

CARENABRÍS UNIVERSAL MODELO / UNIVERSAL WINDSHIELD MODEL / UNIVERSAL WINDSCHUTZSCHEIBE MODEL
UP & DOWN

Ref.: 2193



	<p>ALLEN</p> <p>Nº 3 Nº 5</p>	<p>Nº 13</p>	<p>PHILLIPS</p>
--	-----------------------------------	--------------	-----------------

 1 persona 1 person	 25 min	<p>Fácil - Easy</p> <p>Media-Intermediate</p> <p>Difícil-Difficult</p>
---------------------------	------------	--

CARENABRÍS UNIVERSAL MODELO / UNIVERSAL WINDSHIELD MODEL / UNIVERSAL WINDSCHUTZSCHEIBE MODEL UP & DOWN

INSTRUCCIONES DE MONTAJE - MOUNTING INSTRUCTIONS - MONTAGEANLEITUNG

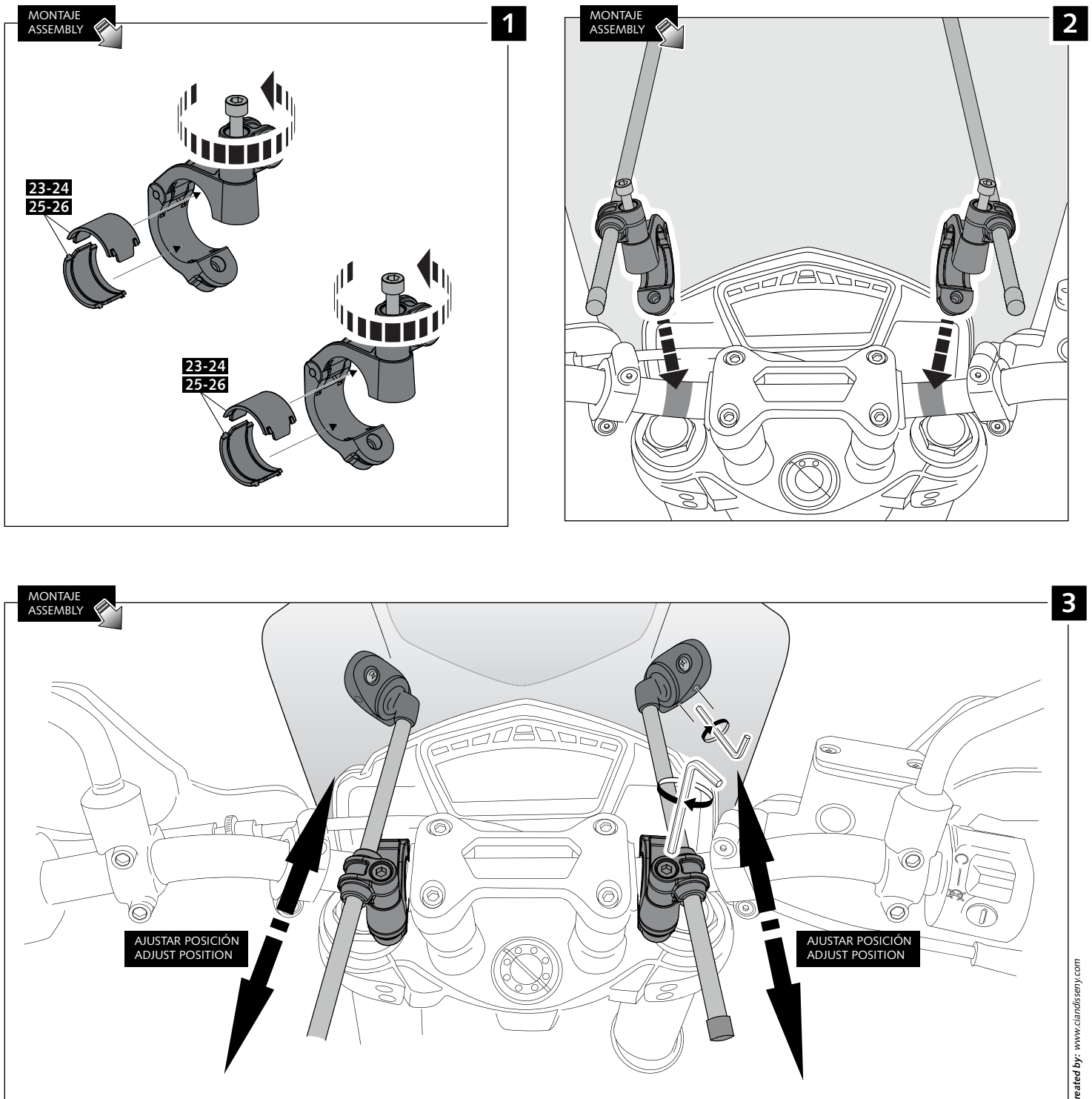

CARENABRÍS UNIVERSAL MODELO / UNIVERSAL WINDSHIELD MODEL / UNIVERSAL WINDSCHUTZSCHEIBE MODEL
UP & DOWN

MONTAJE OPCIONAL DE SOPORTES DE REFUERZO
MOUNTING FOR OPTIONAL REINFORCEMENT BRACKETS
OPTIONALE MONTAGE VON VERSTÄRKUNGHALTERUNGEN

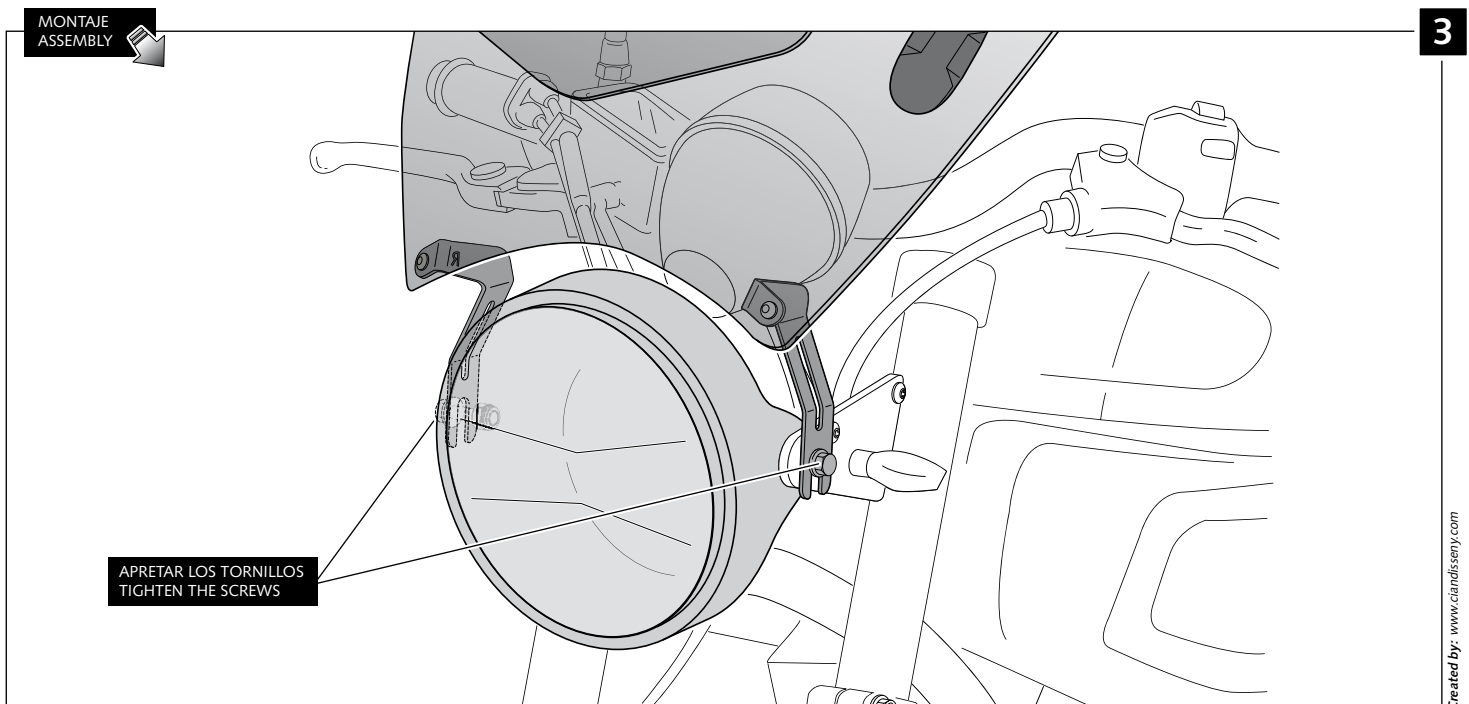
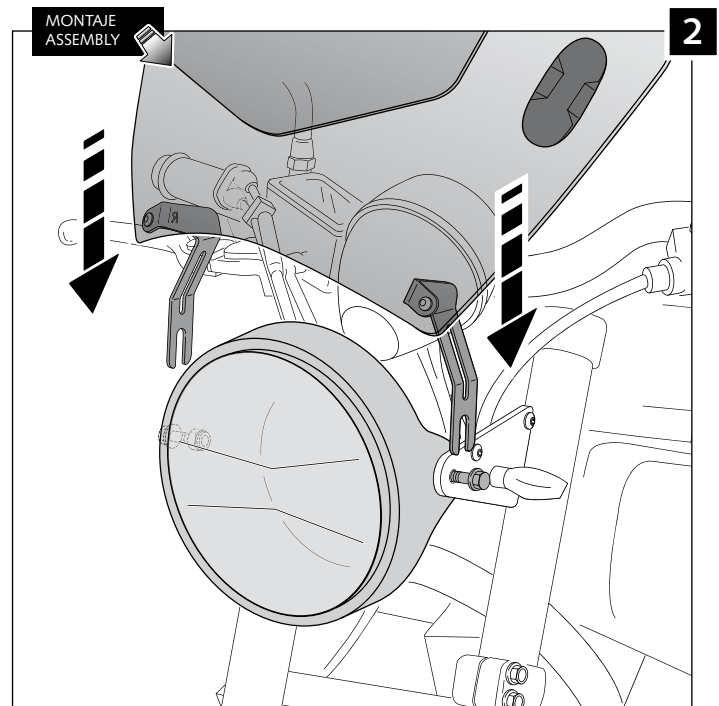
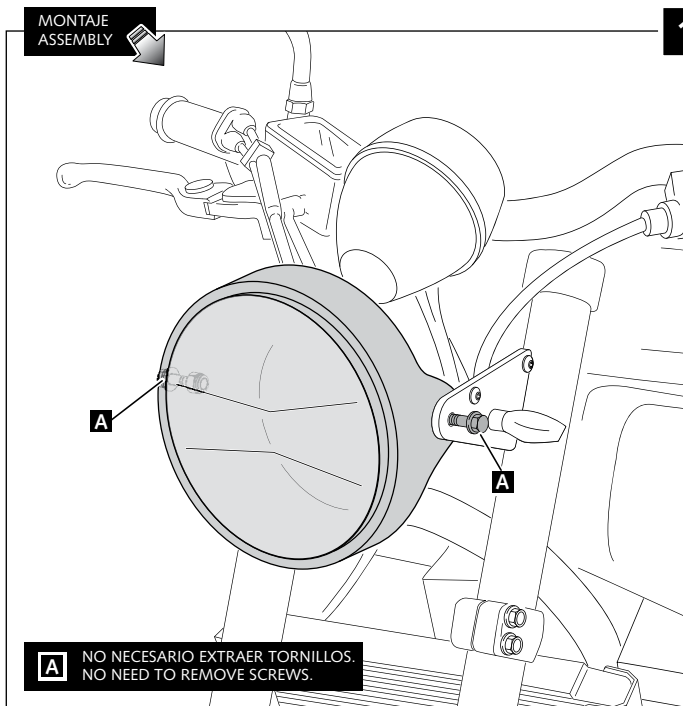





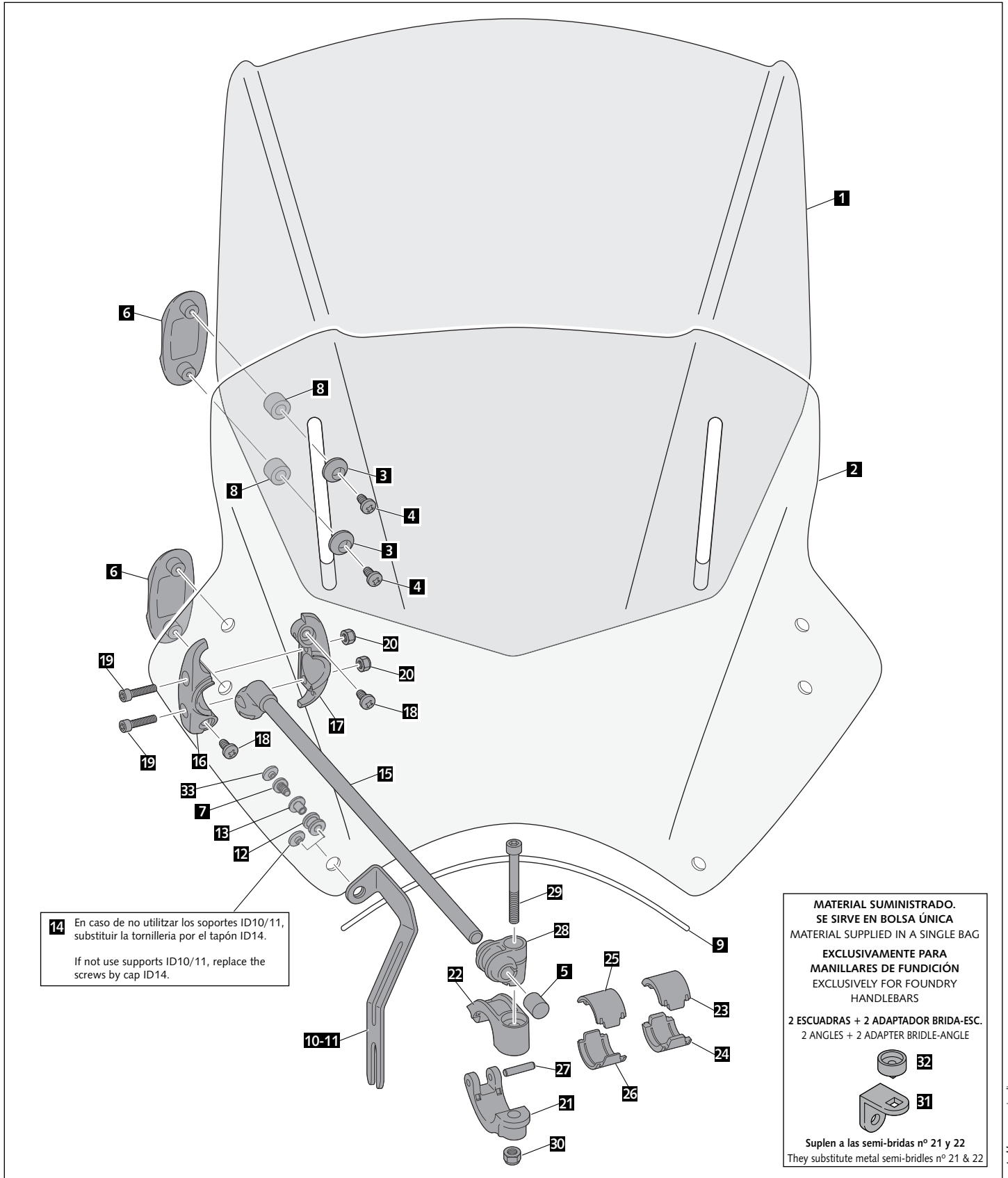











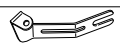
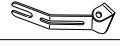













CARENABRÍS UNIVERSAL MODELO / UNIVERSAL WINDSHIELD MODEL / UNIVERSAL WINDSCHUTZSCHEIBE MODEL

UP & DOWN



CARENABRÍS UNIVERSAL MODELO / UNIVERSAL WINDSHIELD MODEL / UNIVERSAL WINDSCHUTZSCHEIBE MODEL UP & DOWN

ID	PIEZA / PART	DESCRIPCIÓN	DESCRIPTION	QTY	REF.
1		Pantalla superior	Higher windshield	1	2193H/WM3
2		Pantalla inferior	Lower windshield	1	2193H/WM3
3		Arandela cónica de plástico Ø20 Ø6	Ø20 Ø6 plastic conical washer	4	ARANDENN20-030
4		Tornillo Ø4,5 x 25 DIN7505A Negro	Ø4,5 x 25 DIN7505A screw (black)	4	TORNI-D7505-778
5		Tope de plástico	Plastic cover	2	TOPEE-VPGT--8/4
6		Soporte de plástico	Plastic washer with sticker	4	CONJU-S3PCC-003
7		Tornillo Allen M5 x 11 Ø11 ISO 7380	M5x11 Ø11 ISO 7380 Allen Screw	2	TORNI-AI----520
8		Distanciador Nylon negro Ø20 x Ø10,5 x 15	Ø20 x Ø10,5 x 15 separator	4	ARAND-----779
9		Ribete faro ahumado	Smoke trim	1	RIBETEHP--900H
		Ribete faro transparente	Clear trim		RIBETETP---0900
10		Soporte derecho	Right support	1	SOPOR-2P-3-UP&D
11		Soporte izquierdo	Left support	1	SOPOR-2P-3-UP&D
12		Silentlock M5 Ø12 x Ø6 x 9	M5 Ø12 x Ø6 x 9 silentblock	2	AROPASACABLES-1
13		Casquillo con valona Ø12 x Ø6,8 x 7,3	Ø12 x Ø6,8 x 7,3 arrowhead	2	CASQUI-1A---750
14		Tapón paralelo	Parallel cap	2	TAPON-----780
15		Varilla Ø9 con bola 90°	Ø9 Bar with 90°	2	VARILI9X200-577
16		Brida rótula L	L ball bearing bridle	2	BRIROT01-1-PR16
17		Brida rótula R	R ball bearing bridle	2	BRIROT02-1-PR16
18		Tornillo Philips Ø5x10mm	Ø5x10mm Philips screw	4	TORNIP510---233
19		Tornillo Allen M5x20 inox DIN912	M5x20 DIN912 Allen screw	4	TORNI-D912--748
20		Tuerca autoblocante M5 DIN982 INOX	M5 DIN982 selft-locking nut	4	TUERCA-D982-746
21		Semi-bridá corta	Short semi-bridle	2	BRIDAANT-0-PR16
22		Semi-bridá larga	Large semi.-bridle	2	BRIDAPOS-0-PR16
23		Casquillo semi-bridá larga para manillar de Ø22	Large semi.-bridle arrowhead - handlebar Ø22	2	CAS29-22-0-PR16
24		Casquillo semi-bridá corta para manillar de Ø22	Short semi.-bridle arrowhead - handlebar Ø22	2	CAS29-22-0-PR16
25		Casquillo semi-bridá larga para manillar de Ø26	Large semi.-bridle arrowhead - handlebar Ø26	2	CAS29-26-0-PR16
26		Casquillo semi-bridá corta para manillar de Ø26	Short semi.-bridle arrowhead - handlebar Ø26	2	CAS29-26-0-PR16
27		Pasador cilíndrico Ø4x20mm	Ø4x20mm cross dowel pin	2	VARILI4X20--576
28		Bridá varilla	Dispstick bridle	2	FIXVARLL-0-PR16
29		Tornillo Allen M6x50 DIN912	M6x50 DIN912 Allen screw	2	TORNI-D912--473
30		Tuerca M6 autoblocante	M6 selft-locking nut	2	TUERCA-D982-745
31		Escuadra	Angle	2	SOPORT30X30-581
32		Adaptador brida-esquadra	Adapter bridle - angle	2	FIXSOPOR-0-PR16
33		Tapón tornillo M5 ISO7380	M5 ISO7380 screw cap	2	TAPON-----85